

LUONTO®

ELFIN ASSEMBLY

Locating and installing the legs

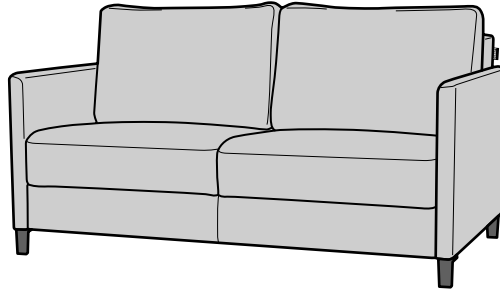
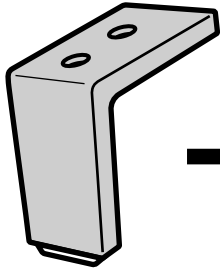

INCLUDED

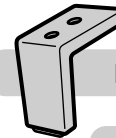

Metal Legs X4

Hex Wrenches X1



M6X25mm X8



ATTENTION!

The Legs for your Luonto Sofa are secured to the top of the seat cushion or beneath the seat cushion (in the no-sag springs) depending on the sofa or leg style.

2-Persons
are required



1

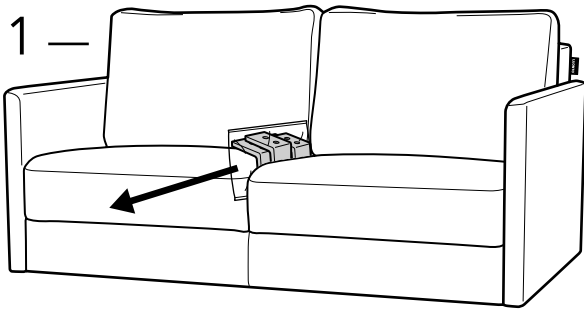

Remove the legs from the top of the seat cushion.

2

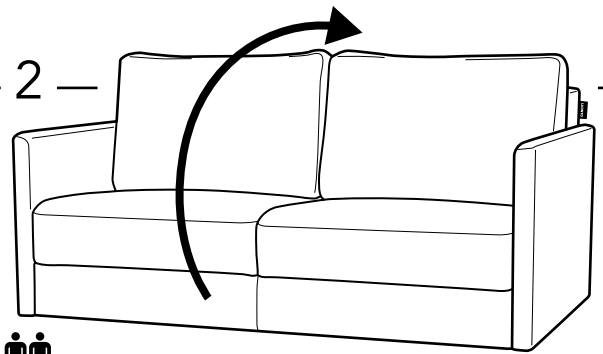

Turn the sofa to the backside.

3

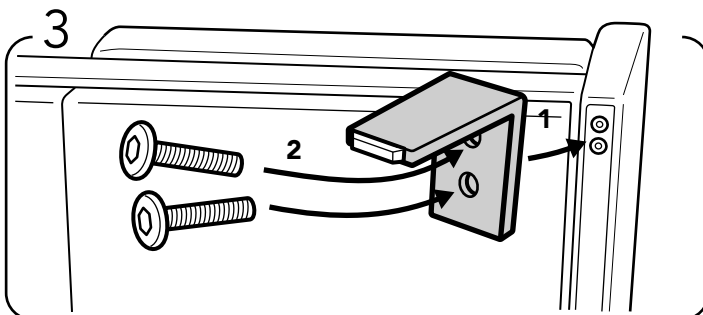

Mount the metal leg in place and screw the 2 (M6X25mm) bolts into the pre-drilled holes.

4

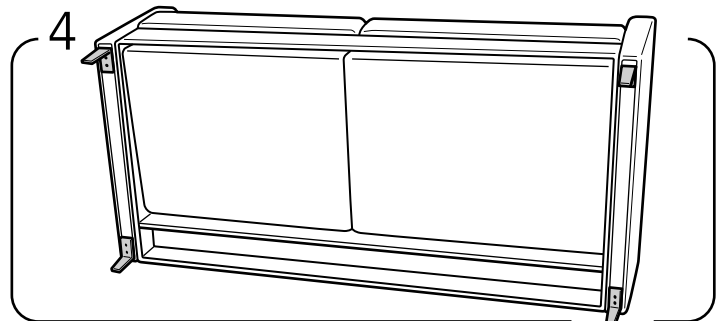

Repeat the same process for the 4 legs.

5

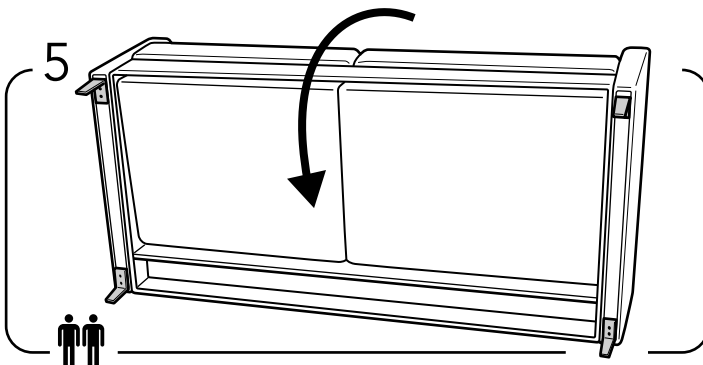

Carefully, turn the sofa upright and ensure each of the legs are installed properly.

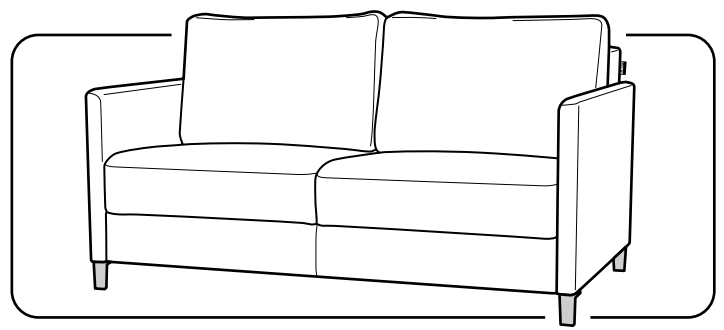

This is how the final product should look like

